

## Technical Specifications / Engineering Submittals

Raritan Model Number: PX3-5903V

rev20200701

### LINE DRAWING

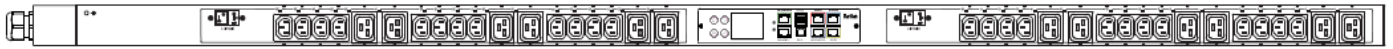

### FEATURES

Energy Metering	Voltage (V), Current (A), Active Power (kW), Real Power (kVA), Energy (kWh), Power Factor
Metering Accuracy	ISO/IEC 62053-21 1%
Metering per Input Line	Yes
Metering per Branch Circuit Breaker	Yes
Metering per Output Receptacle	Yes
Remote Outlet Switching	Yes
Environmental Sensor Ready	Yes
Replaceable Controller	Yes
Compatible Sensors	Temperature, Humidity, Air Flow, Differential Pressure, Water Leak, and Contact Closure
Networking	Gigabit (10/100/1000 BaseT) Ethernet port; secondary, redundant (10/100/1000 BaseT) Ethernet port. Optional WiFi (802.11a/b/g/n)
Remote Management	HTTP(s); SSH; Telnet; RS-232 (Serial); Power IQ; SNMP version v2/v3; SMTP; JSON-RPC; Modbus over TCP
Cascading	Yes, Max 16 PDUs can be daisy chained using a single Ethernet or USB connection
Onboard Display	Color, matrix LCD display : Voltage, current, or active power (per line, per breaker, or per receptacle / outlet); Alarms; Configuration information (name, ratings, IP / Networking information); Auto-flip orientation
Embedded Processor	ARM Cortex A5 500MHZ (Atmel A5D21C), 16MB SPI Flash, 128MB DDR2 RAM

## Technical Specifications / Engineering Submittals

Raritan Model Number: PX3-5903V

rev20200701

### INPUT

Input Plug	NEMA L6-30P (2P3W)
Cord Length	3 meters (9.84 feet) standard
Cord Entry	Bottom-bottom feed
Cable Type	IP44("splashproof")
Number of Power Cords	1
Maximum Input Current	30A
Nominal Input Voltage	208V
Rated Input Voltage	200 - 240V
Input Frequency	50/60Hz
Power Capacity	4.8kVA at 200V, 5.8kVA at 240V

### OUTPUT

Nominal Output Voltage	208V
Rated Output Voltage	200 - 240V
Receptacles (Output Connections)	(24) IEC320 C13, 12A (12) IEC320 C19, 16A
Securelock Support	Yes
Cord Retention	Yes
Overload Protection	(2) LEGBXA66-20

### PHYSICAL

Color	Black powder coat (custom colors available)
Unit Dimensions (WxDxH)	2.1" x 2.6" x 70.1" ; 52mm x 65mm x 1780mm
Unit Weight	6.4 kg
Shipping Weight	8.8 kg
Shipping Dimensions (WxDxH)	11.02" x 4.53" x 80.91" ; 280mm x 115mm x 2055mm
Mounting	G2-RACK-FOR-ZU

## Technical Specifications / Engineering Submittals

Raritan Model Number: PX3-5903V

rev20200701

### ENVIRONMENTAL

---

Operating Temperature	60°C
Operating Relative Humidity	85%
Operating Elevation	0-6000ft
Storage Temperature	-25 to 65°C
Storage Humidity	0-100%
Storage Elevation	0-10000ft

---

### CONFORMANCE

---

Regulatory Approvals	UL Listed, Canada ICES-003, Part 15 Class A of the FCC rules, RoHS compliant
Warranty	Standard 2 years manufacturer warranty (Extended warranty available for purchase)

---

## Technical Specifications / Engineering Submittals

Raritan Model Number: PX3-5903V

rev20200701

### CONTROL PANEL

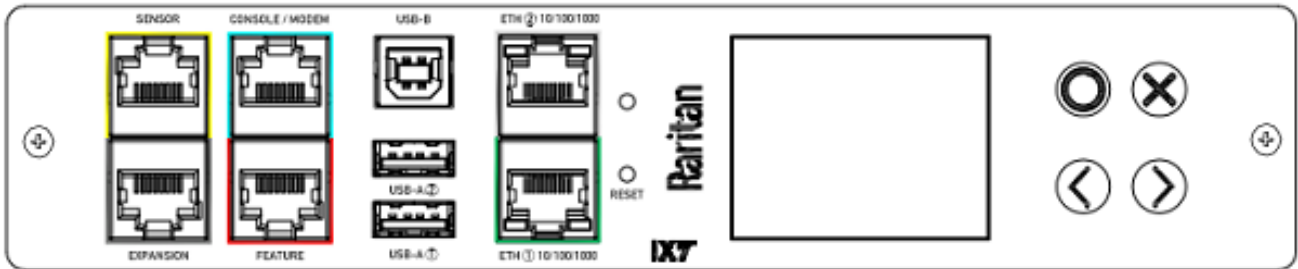

# Technical Specifications / Engineering Submittals

Raritan Model Number: PX3-5903V

rev20200701

## ELECTRICAL (ONE LINE) DIAGRAM

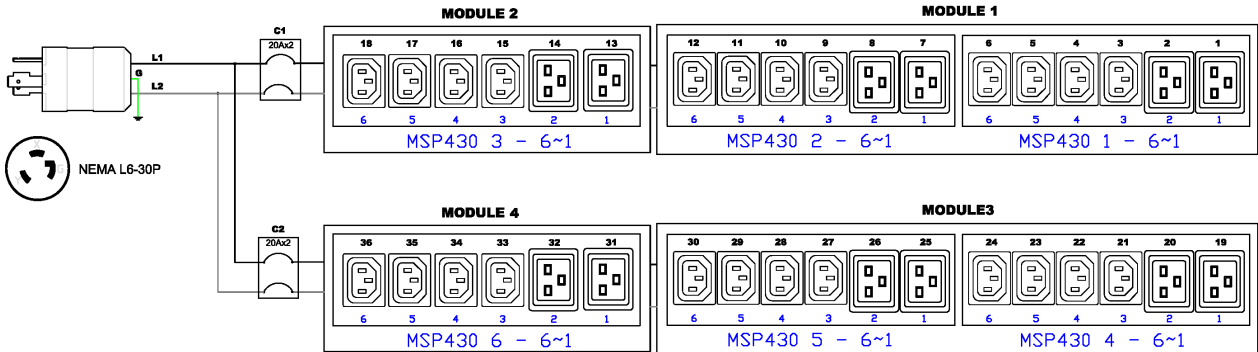

## Technical Specifications / Engineering Submittals

Raritan Model Number: PX3-5903V

rev20200701

### MECHANICAL DIAGRAM

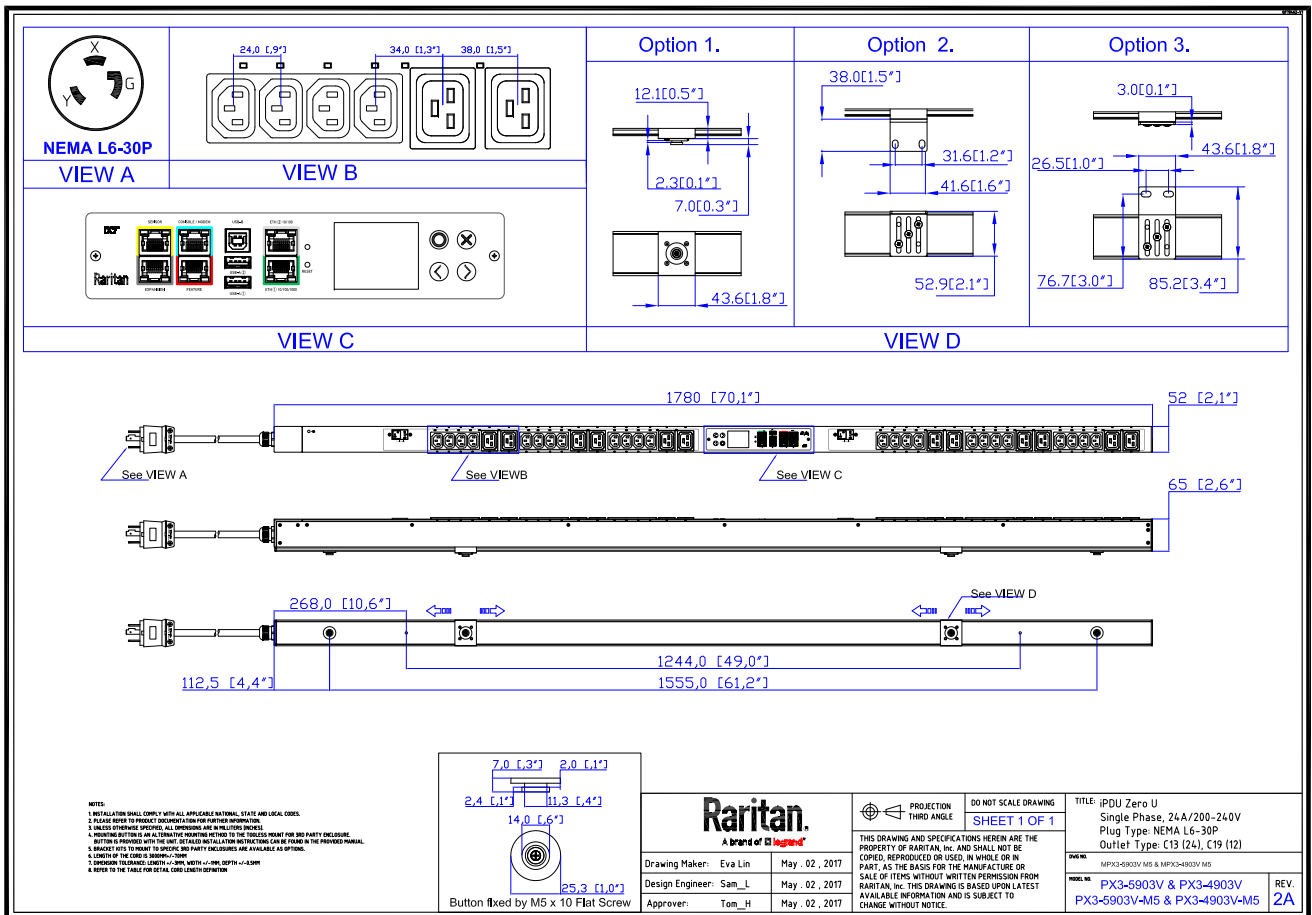

## Technical Specifications / Engineering Submittals

Raritan Model Number: PX3-5903V

rev20200701

### Mounting Diagram (G2-RACK-FOR-ZU)

250-70-0104-00



250-80-0011-00



250-70-0007-00

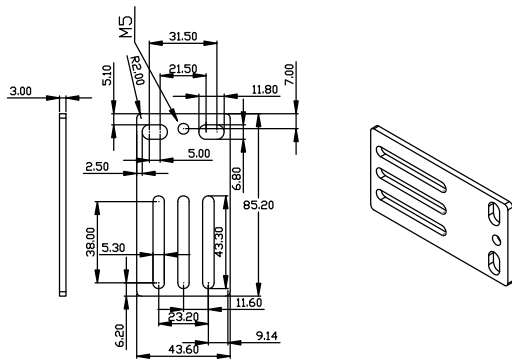

250-70-0093-00

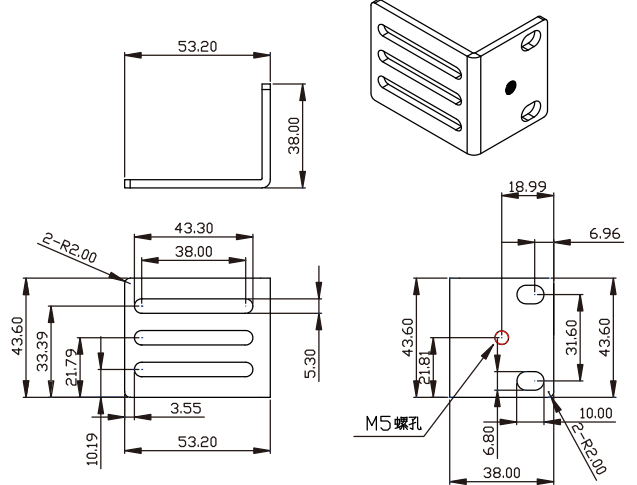

**Technical Specifications / Engineering Submittals**

Raritan Model Number: PX3-5903V

rev20200701

**TRIP CURVE**

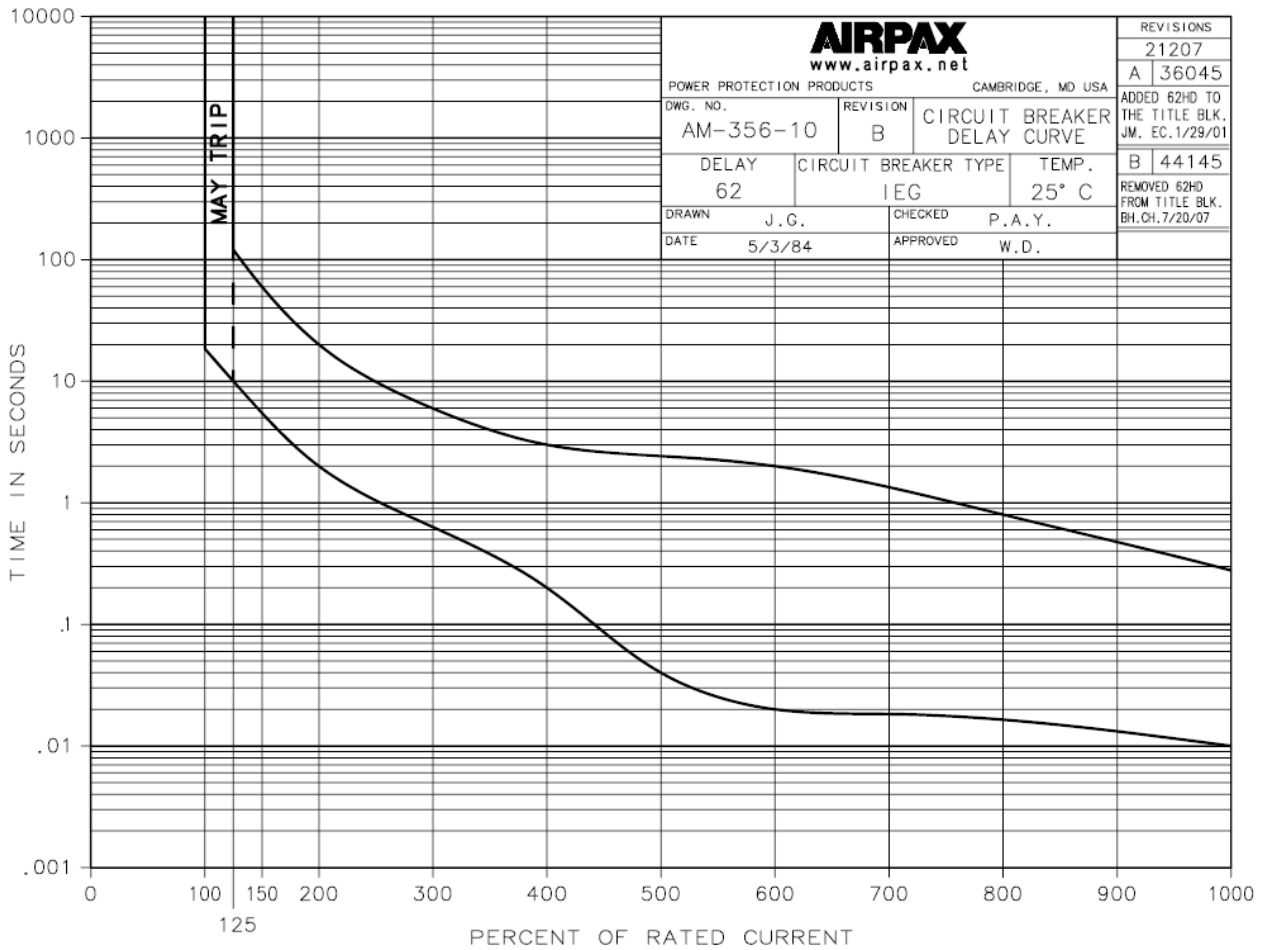

C-1009-1 5/98 32556

This file generated on: Wed, July 01, 2020 - 07:40:19